

Project Name:	Type:
Product Code:	Date:



VANILLA LINK

The Vanilla Link is a unique connecting system that allows the creation of long linear runs without interlink cables while maintaining the same LED pitch. Its ultra-compact form factor permits installation in tight spaces.

A wide range of optic options including narrow, medium, surface grazing, and wall wash beam makes Link LED an excellent choice for cove, surface grazing, and Wall-washing applications. IP20



PERFORMANCE

	LED			
CCT:	2700K	3000K	3500K	4000K
LUMENS:	1884lm/Link	1944lm/Link	2040lm/Link	2148lm/Link
WATTAGE:	13.2 WATTS/LINK			
CRI:	90 CRI			
LED LIFE:	50,000 hours			
POWER:	48V			
SDCM:	3 STEP			
CCT:	2700K	3000K	3500K	4000K

MOUNTING DIMENSIONS

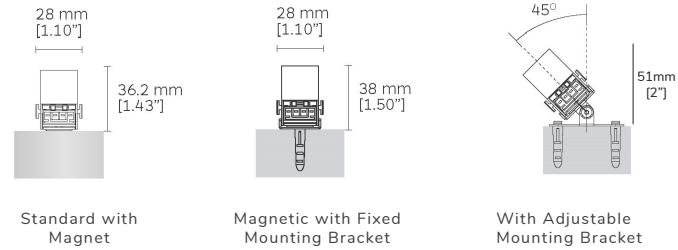

ACCESSORIES DIMENSIONS

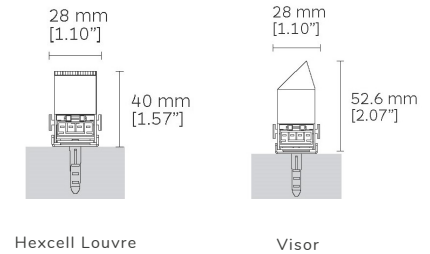

KEY DIMENSIONS

Min Length = 12.17" (309mm) / 12 x LED, 1 Link

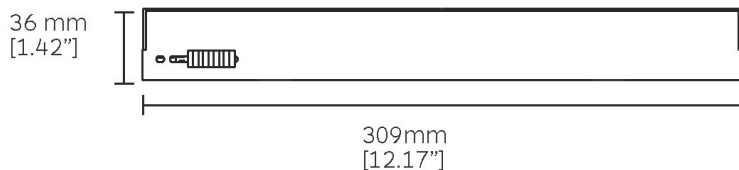
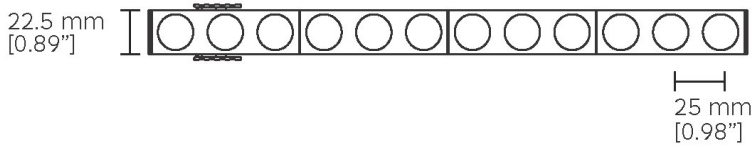

G146



G145



ORDER INFORMATION

Order Code											
MAKE	PROFILE	COLOR TEMP		OPTICS	FINISH		DRIVER	MOUNTING		ACCESSORIES	
VAN	G146	27K	2700K	ST 17°	BO	Black	0-10V	FM	Fixed Mounting	CFR	Color Filter Red
		30K	3000K	NF 22°	WO	White*	DALI DIM*	AM	Adjustable Mounting	CFG	Color Filter Green
	35K	3500K	FL 29°	PB	Polished Brass*				CFB	Color Filter Blue	
	40K	4000K	EL 15°x50°	GO	Gold*				CFY	Color Filter Yellow	
				WW						CCF	Custom Color Filter*
				VISOR						H	Hexcell Louvre
				ST 17°						OM	Optical Module
				NF 22°						FPC	Flexible Power Cable
				FL 29°						PF	Power Feed
				EL 15°x50°							
			WW								

*REQUIRES MINIMUM ORDER QUANTITY

ACCESSORIES

COLOR FILTER

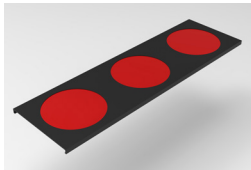

Color Filter Red

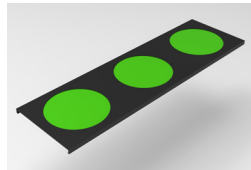

Color Filter Green

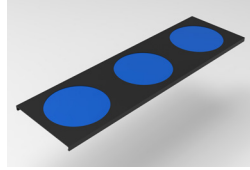

Color Filter Blue

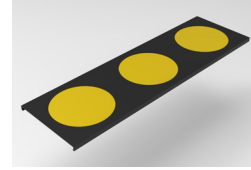

Color Filter Yellow

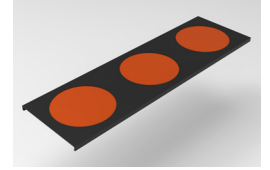

Custom Color Filter

OPTIC/ACCESSORIES

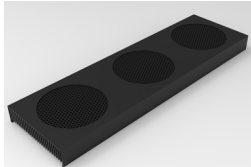

Hexcell Louvre

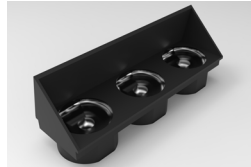

Optic w/Visor

MOUNTING ACCESSORIES



Fixed Mounting Bracket



Adjustable Mounting Bracket

POWER ACCESSORIES



Flexible Power Cable
39" (1000mm)



Power Feed
19" (500mm)

TECHNICAL FACTS

G146

Min.L = 309mm (12.17") | 12xLED, 1 Link

G146 with side power feed cable. The following LINK can only be connected from 1 side.
Input Power Cable Length 600mm

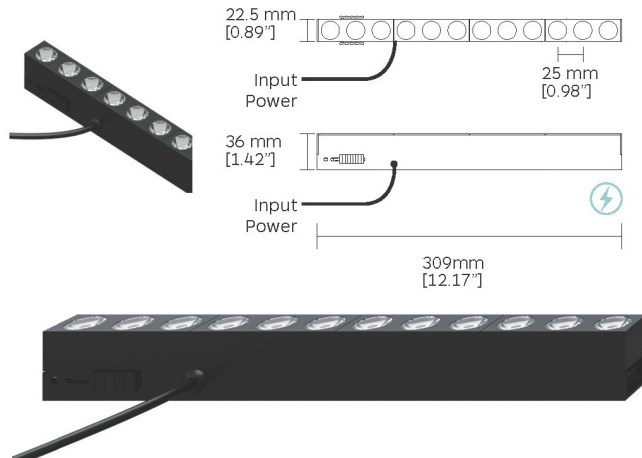

G145

Min.L = 309mm (12.17") | 12xLED, 1 Link

G145 can be connected from both sides.

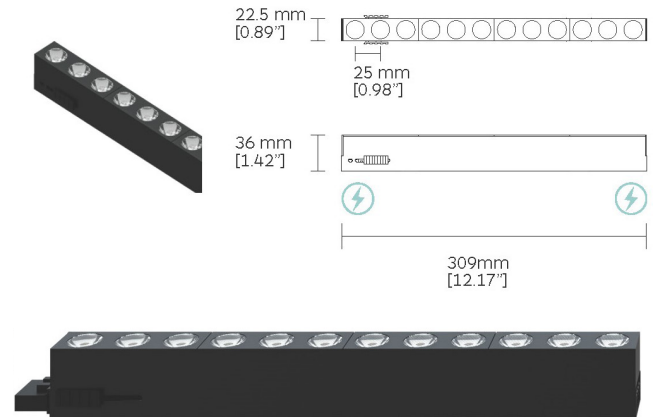

WIRING DIAGRAM

WIRING TO A UNIVERSAL JUNCTION BOX

6 LINK MAX RUN

