

Project Name:	Type:
Product Code:	Date:

VANILLA 10W CC DRIVER



10W CC DRIVER

The Vanilla 10W CC Driver is a constant current driver with multiple dimming options. The 5 in 1 dimming options are, Triac, 0-10V, 1-10V, Potentiometer, 10V. The driver has a dimming range of 1-100%. Along with this the driver has short circuit and over temperature protection. The drivers come with the C-06 enclosure.

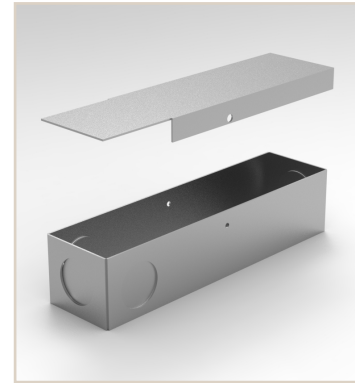

PERFORMANCE

	5 IN 1 DIMMING LED DRIVER
	10W
VOLTAGE:	100-277VAC
DIMMING RANGE:	1-100% (FLICKER FREE)
OUTPUT:	CONSTANT CURRENT
CLASS:	CLASS 2 / CLASS P
CURRENT TOLERANCE:	±5%
ENCLOSURE:	C-06
DIMMING:	Triac / 0-10V / 1-10V / 10V PWM / POTENTIOMETER
STANDARD:	UL8750, CLASS 2
WORKING TEMP:	-40~+140°F (-40~+60°C)
RATING:	IP20

KEY DIMENSIONS

10W | C-06

Length: 6" (15.24cm) Width: 1.65" (4.19cm) Height: 1.42" (3.6cm)

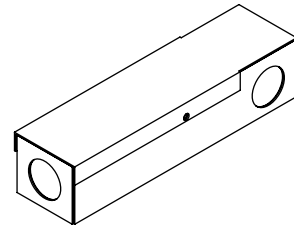
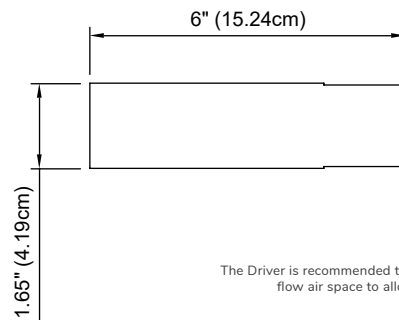
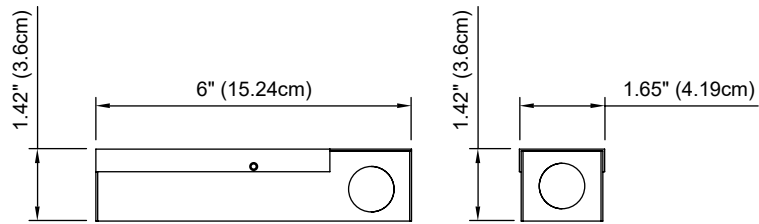

The Driver is recommended to be mounted in at least 2" of free flow air space to allow for proper ventilation.

WIRING DIAGRAM

10W - MULTIPLE FIXTURES REQUIRE WIRING IN SERIES - AWG#16

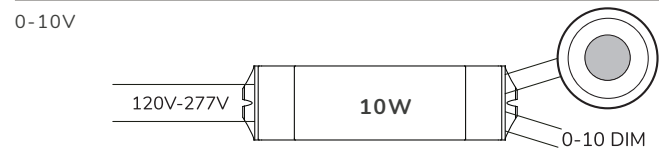
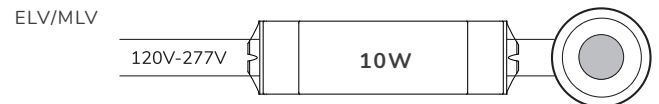

PLUG-IN CORD OPTION

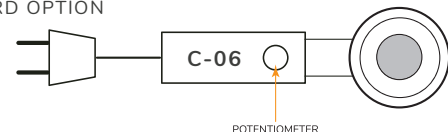

POTENTIOMETER

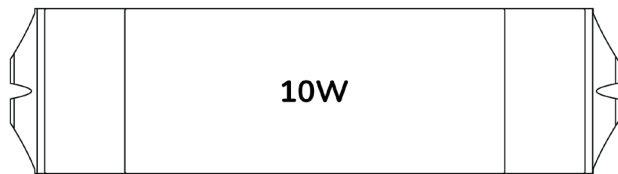

W : 1.16" H : 0.79" L : 5.3"

ORDER INFORMATION









Order Code

MAKE	MODEL
VAN	DVR 10W CC-USD

OPTION
PLUG-IN AND 6' CORD + POTENTIOMETER

TECHNICAL SPECIFICATIONS

10W DRIVER

RATED CURRENT: 	100mA 	150mA 	200mA 	250mA 	300mA 	350mA 	400mA 	450mA 
CURRENT TOLERANCE:	±5%							
DC VOLTAGE:	3-42V	3-42V	3-42V	3-40V	3-33V	3-29V	3-25V	3-22V
RATED POWER:	4.2W	6.3W	8.4W	10W	10W	10W	10W	10W
RATED INPUT VOLTAGE:	100-277VAC							
RATED FREQUENCY:	47-63Hz							
POWER FACTOR:	99%@120VAC 60Hz 94%@277VAC 60Hz							
EFFICIENCY (Typ.):	76.01%@120VAC 60Hz 76.02%@277VAC 60Hz							
AC CURRENT (MAX):	0.138A							
INRUSH CURRENT (Typ.):	3.97A,4.4US @ 50%IPEAK @ 120V 9.17A,4.4US @ 50%IPEAK @ 277V							
LEAKAGE CURRENT:	<0.50mA							
SHORT CIRCUIT:	CONSTANT CURRENT MODE, RECOVERS AUTOMATICALLY AFTER FAULT CONDITION IS REMOVED							
OUTPUT NO-LOAD VOLTAGE:	48-54V							
OVER TEMPERATURE:	AMBIENT TEMP. OVER 50±5°C (122±9°F), OUTPUT CURRENT WILL BE REDUCED TO 50%; AMBIENT TEMP. OVER 60±5°C (140±9°F), OUTPUT WILL BE OFF, RECOVERS AUTOMATICALLY							
PROTECTION CLASS:	CLASS 2							
WORKING TEMP:	-40-+60°C (-40-+140°F)							
WORKING HUMIDITY:	20-90%RH, NON-CONDENSING							
STORAGE TEMP:	-40-+80°C (-40-+176°F)							
STORAGE HUMIDITY:	10-95%RH							
TEMP COEFFICIENT:	±0.03%/°C (0-50°C) (32-122°F)							
VIBRATION:	10-500Hz, 2G 10min./1 CYCLE, PERIOD FOR 60min. EACH ALONG X,Y,Z AXIS							
SAFETY STANDARDS:	UL8750							
WITHSTAND VOLTAGE:	I/P-O/P:1.80KVAC							
ISOLATION RESISTANCE:	I/P-O/P:100MΩ / 500VDC / 25°C / 70%RH							
EMC EMISSION:	FCC 47 CFR PART 15, SUBPART B							