

Project Name:	Type:
Product Code:	Date:

VANILLA LARGE 3 ADJUSTABLE DOWNLIGHT



Vanilla Large 3 Adjustable Downlight

The Vanilla product family is a recessed adjustable downlight providing high visual comfort thanks to a deep recessed LED Engine. Vanilla comes with a modular and tool free LED-engine and optical accessories that are field changeable. Fixture is serviceable through the aperture. The Body is made of high grade Aluminum. The fixture is tilttable vertically 0-35° and rotatable horizontally 355°. Adjustable 35° always inside ceiling level. The fixtures is provided standard with retrofit housing. IC (title 24) housing available as an option for 3 inch version of fixture.



PERFORMANCE

	STATIC WHITE LED	WARM DIM LED
CCT:	2700K / 3000K	1800K - 3000K
CRI:	97 CRI	90 CRI
WATTAGE:	12 WATTS (350 mA)	10 WATTS (350 mA)
LUMENS:	1060 Delivered	998 Delivered
SDMC:	2 Step	2 Step
CCT:	2700K 3000K	1800K — 3000K

BEAM SPREAD	SPOT	NARROW FLOOD	FLOOD

KEY DIMENSIONS

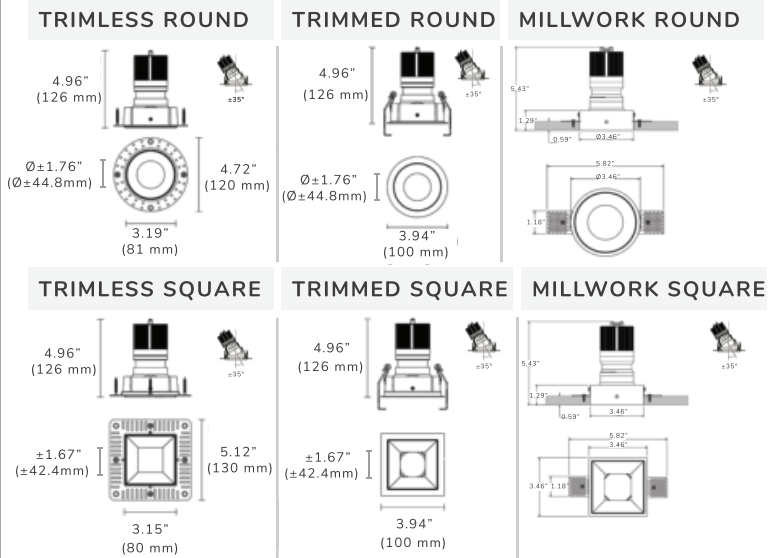

DRIVER SPECIFICATIONS

	STATIC WHITE (E4)	WARM DIM (EW)
DIMMING:	ELV 2 Wire	ELV 2 Wire
LED CLASS:	2 Output	2 Output
AC INPUT	110-277 VAC 0.23 - 0.09A 50/60 HZ	110 - 277 VAC 0.23-0.09A 50/60 Hz
DC OUTPUT:	350mA	350mA

HOUSING SPECIFICATIONS

RETROFIT DRIVE ENCLOSURE SPECS | C-06

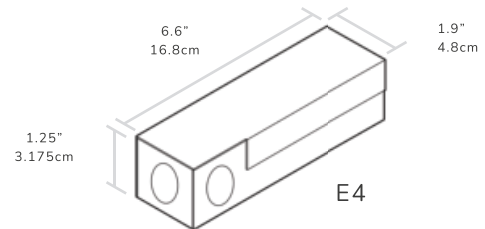

ELV Standard 2-Wire Dimming



*FOR OTHER DIMMING STYLES CONTACT LGN

TRIM OPTIONS

R4 - ROUND					
TRIM TYPE	TL TRIMLESS		TR TRIMMED		FINISH
FX FLAT IP20 (DRY)					 W WHITE
CX CONCAVE IP20 (DRY)					 B BLACK
FH FLAT HEXCELL IP20 (DRY)					 C CUSTOM
FS FLAT SOLITE IP44 (WET)					
CS CONCAVE SOLITE IP44 (WET)					
S4 - SQUARE					
FX FLAT IP20 (DRY)					
CX CONCAVE IP20 (DRY)					
FH FLAT HEXCELL IP20 (DRY)					
FS FLAT SOLITE IP44 (WET)					

ORDER INFORMATION

Order Code

VAN	PROFILE	TRIM TYPE	FINISH	TEMP	OPTICS	DRIVER	DRIVER	ACCESSORIES
VAN	RTR4 ROUND TRIMMED	FX FLAT IP20	W WHITE	274 2700K	11	E4 ELV	RT RETROFIT	X2 2 FIXTURE TRIMLESS MUD KIT
	RTL4 ROUND TRIMLESS	CX CONCAVE - IP20	B BLACK	304 3000K	23	XX OTHER**	IC IC (TITLE 24)	X4 4 FIXTURE TRIMLESS MUD KIT
	STR4 SQUARE TRIMMED	FH FLAT HEXCELL -IP20	C CUSTOM *		34			
	STL4 SQUARE TRIMLESS	FS FLAT SOLITE SHOWER - IP44		WD4 (1800 K - 3000K)	20	EW ELV**		
	RML4 ROUND MILLWORK	CS CONCAVE SOLITE SHOWER -IP44			30			
					38			
SML4 SQUARE MILLWORK			60					

*CUSTOM FINISHES REQUIRE A MINIMUM QUANTITY OF 25 FIXTURES

**OTHER DIMMING OPTIONS AVAILABLE UPON REQUEST

*** IC HOUSING REQUIRED FOR JA8 T24 COMPLIANCE

****CONCAVE SOLITE ONLY AVAILABLE ON ROUND TRIM TYPE

***** ONLY CONCAVE SQUARE MILLWORK TRIM IS AVAILABLE

***** IC HOUSING IS NOT COMPATIBLE WITH THE X2 or X4 ACCESSORIES

ACCESSORIES

Multi X2 - 6" Center to Center Spacing

ROUND

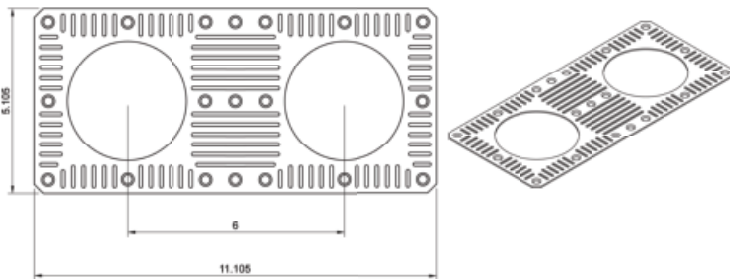

SQUARE

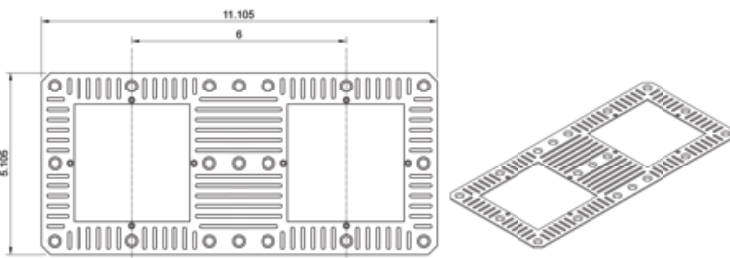

Multi X4 - 6" Center to Center Spacing

ROUND

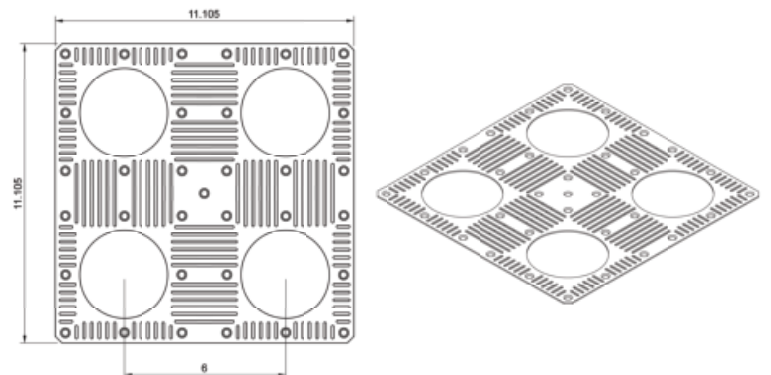

SQUARE

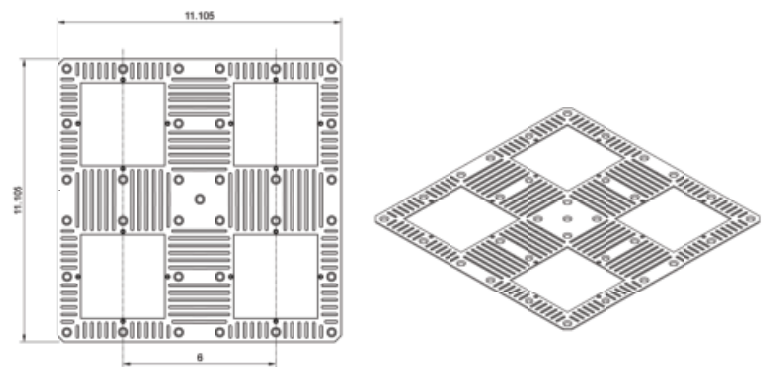

Fixture Components

Housing/Enclosure		<p>Power Source 120 V Connection</p>	<p>Housing/ Enclosure Above ceiling IC housing or Above ceiling RT Retrofit Housing enclosure for ELV driver and line voltage connection</p>	<p>Housing Enclosure Options RT - Retrofit Retrofit housing for all other</p>
Driver		<p>Driver Low Voltage ELV Standard 2 Wire Dimming. Other Dimming Styles available through custom orders. Contact LGN.</p>	<p>IC - Insulated Ceilings IC Housing required for Insulated ceilings. Required JA8 T24 Compliance</p>	
Light Source		<p>Light Source LED engine with 3 CCT options. Adjustable gimbal trim allows for aimable spot lighting.</p>		
Optics		<p>Optics Field-interchangeable optic reflectors with spot, narrow flood, and wide flood beam spread options.</p>		

Housing / Retrofit Enclosure Specifications

E4 (3 Inch) Product Data	
RT - Retrofit	IC - Insulated Ceiling Housing Enclosure (IC TITLE 24)
Specifications:	Specifications:
Dimensions: 6.6" (16.8cm) x 1.9" (4.8cm) x 1.25" (3.175cm)	Dimensions: Shallow: 8.5"x10.5"x4.75" Deep: 8.5"x10.5"x6.75"
IP Rating: IP 20	IP Rating: IP 20
Light Source: LED	Light Source: LED
AC Input: 110-277 VAC - 0.23-0.09A 50/60 Hz	AC Input: 110-277 VAC - 0.23-0.09A 50/60 Hz

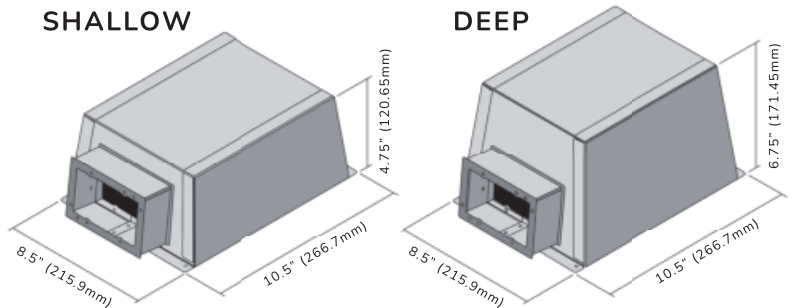
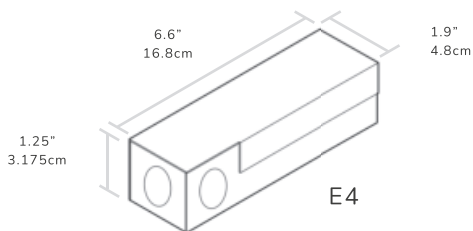

INSTALLATION GUIDE

Trimless

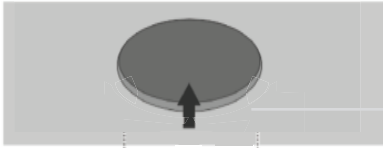

Ceiling Cutout:
3 5/8 inches / 92 mm

MUD PLATE
Required for installation in ceiling cutout

Screws
Plaster rig is installed at ceiling cutout using screws

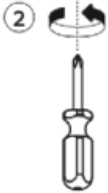

Plaster
Before plastering and painting, cover the opening with cardboard.



Paint
Once finished painting and plastering remove the cardboard cover.

Trimmed

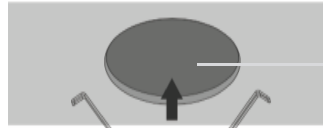

Ceiling Cutout:
3.6 inches/92 mm

Butterfly Clips
Hold trimless fixtures in place

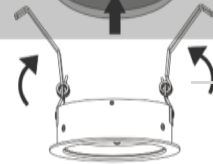

Gimbal Magnets
The gimbal snaps into place via magnets within the trim

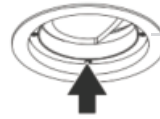

Trim Magnets
The trim type also snaps into place using magnets for stress free installations



Millwork



Millwork Mount:
Installed from the back, with two set screws, height adjustable

Millwork Cutout:
Round: 3.46" (88mm)
Square: 3.46"x3.46" (88x88mm)
see dimensions above for fixture measurements

LED Module
Attached to the adjustable ring will snap into the Millwork mount

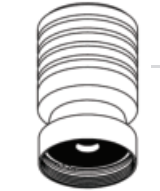

Adjustable Ring
Snaps into the Millwork mount



Trim Magnets
The trim type also snaps into place using magnets for stress free installations

